

ALFA

Vertical multilane stick-pack machines

-  POWDERS
-  GRANULES
-  PASTES
-  LIQUIDS
-  TABLETS



since 1965

 MADE IN ITALY

ALFA Stick-Pack Machines

AUTOMATIC MULTI-LANE STICK MACHINES ALFA

For food, pharmaceutical, chemical and cosmetic sectors

Universal Pack's **ALFA** range are vertical, intermittent-motion packaging machines for single portion stick-packs or shaped sticks. They can be equipped with any dosing system and can accommodate a large range of stick sizes. The machine's output is based on the

number of lanes and cycle speed. The maximum number of lanes is determined by the stick dimensions whilst the cycle speed depends on the product, film, dose, stick format and many other factors.

BASCULATING STICK MACHINES

Suitable for granules and free-flowing products such as sugar, salt, sweetener, pepper, black tea, creamer, instant coffee, instant tea, yeast, pharmaceutical granules and so on.

AUGER STICK MACHINES

Suitable for non free-flowing products containing fat that makes them lumpy, and non free-flowing powders such as coffee, 3-in-1 mixes, cocoa, chocolate powder, milk powder, dry sauce mixes, spices, baking powder, yeast, pharmaceutical powders and so on.

 Granules



 Powders

 Granules



PISTON PUMP STICK MACHINES

Suitable for high viscosity liquids such as ketchup, tomato paste, sauces, mayonnaise, mustard, seasoning, shampoos, toothpaste, cosmetic creams, syrups, ointments, pharmaceutical preparations in gel and so on.

GRAVIMETRIC STICK MACHINES

Suitable for low viscosity liquids such as juices, ice-pop liquids, vinegar, detergent, medicinal liquids and so on.

 Pastes

 Liquids

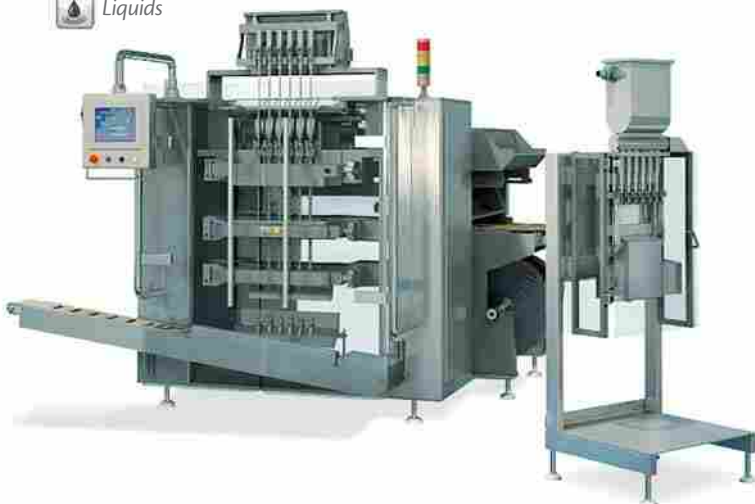

 Liquids



Developing the latest packaging technology since 1965

DOSING SYSTEMS

BASCULATING

For free flowing products

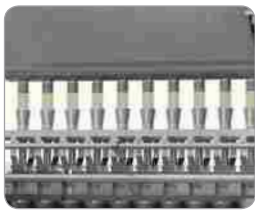
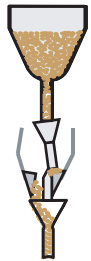

AUGER

For powders, free and non free flowing products

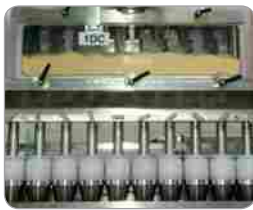

PISTON PUMP

For pasty products

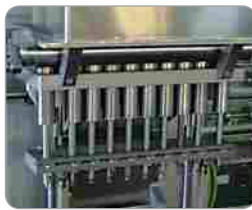
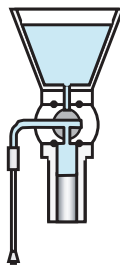

GRAVIMETRIC

For liquid products



ALIGNER DISPENSER

For tablets and similar products

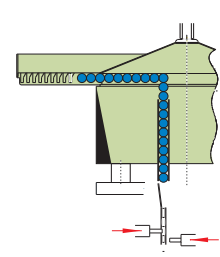

TYPE OF STICK-PACK

STICK-PACK

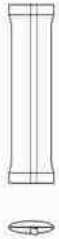

PILLOW STICK



DOUBLE STICK

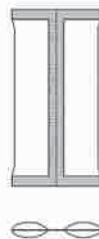

SHAPED STICK



SIDE-FIN STICK



LAYOUTS / TECHNICAL DATA & CHARACTERISTICS / OPTIONS

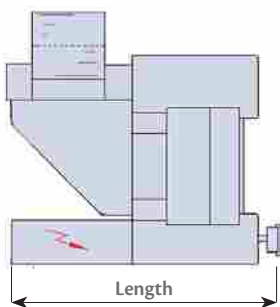

STICK	Min.	Max
Width [mm]	10	140
Length [mm]	30	200
Dose [cm ³]	0,1	300

PRODUCTIVITY	
Output Lanes	up to 2400 stick/min from 2 to 24

REEL	
Max width [mm]	1200
External ø [mm]	600

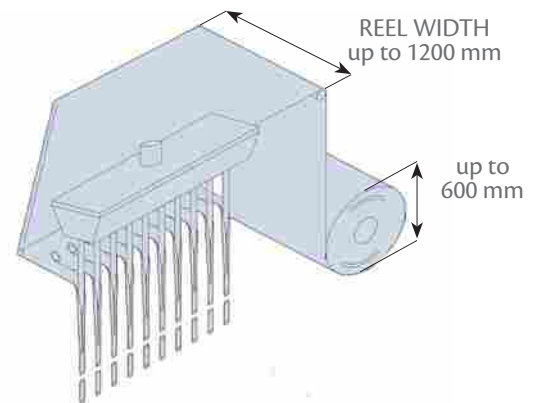

	Width [mm]	Length [mm]	Max sealing width [mm]
Version P	2200	2500	400
Version S	2200	2500	640
Version M	2400	2760	900
Version G	2760	3060	1200

Ergonomic design and space optimization

Synchronised Brushless servomotors

Component codification

Colour touch screen monitor HMI

Quick reel splicing in an easily accessible position

Film tension control and automatic reel alignment

Ink jet, thermal transfer, embossing and laser printing

Inline stick-pack check-weighing with trend control feed-back

Remote factory assistance

Dedicated applications

ALFA FOR SIDE FIN STICK-PACKS

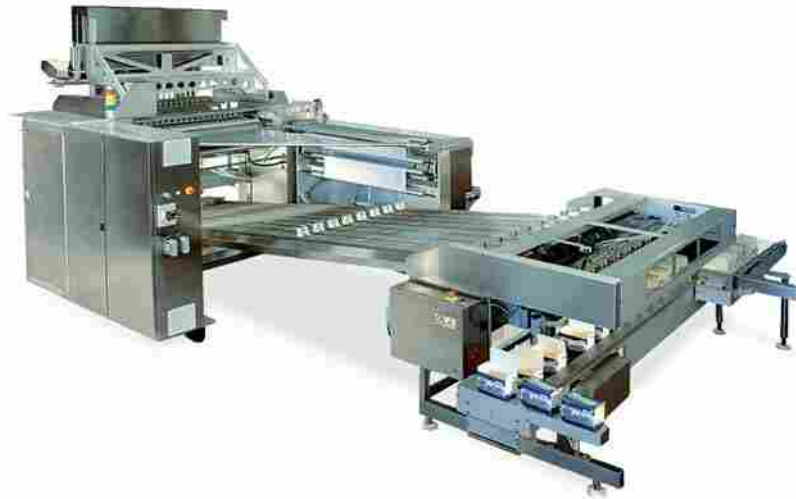

ALFA Universal stick-pack machine design is optimized to produce side fin stick-packs. Side-fin sealing increase printable area on the

stick-pack or customer's artwork. This stick-pack permits an easy open for any kind of products.

ALFA PILLOW STICK-PACKS



ALFA Universal Pack pillow stick-pack machines are designed to meet customer requirements to produce large size stick-packs. The

increased volume inside the stick-pack allows a large quantity of product to be packed.

Totally client-oriented, state-of-the-art packaging solutions

ALFA MODULAR LINE FOR EASY AND FAST SIZE CHANGE



ALFA Universal Pack stick-pack machines, can be equipped with systems to produce different stick sizes. The size change is fast with

rapid disassembly so as production can be rapidly started with the new size.

SYNTHESIS ALFA LINE FOR SHAPED STICKS



ALFA Universal Pack stick-pack machines can produce shaped sticks with a unique design, and can be optimized to comply with any

customer's requirements. Design is important for any customer, and Universal Pack machines are the answer to that.

Wide range of devices and facilities

IN-LINE CHECK-WEIGHING



Checkweigher for inline check-weighing of produced stick-packs with automatic dose regulation (trend control feedback) and rejection of out of range stick-packs, designed and developed by Universal Pack R&D team and constructed in-house.

PICK AND PLACE SYSTEMS



Pick and place systems for positive stick-packs transfer into cartons, designed and developed by Universal Pack's R&D team and constructed in-house.

CIP SYSTEMS



Clean-in-place (CIP) is a system of cleaning the inner surface of nozzles, cylinders, pistons, all pipes and manifolds in the circuit, without disassembly developed by Universal Pack R&D department in accordance with EHEDG Guidelines and 3-A Sanitary standards.

MODIFIED ATMOSPHERE PACKAGING

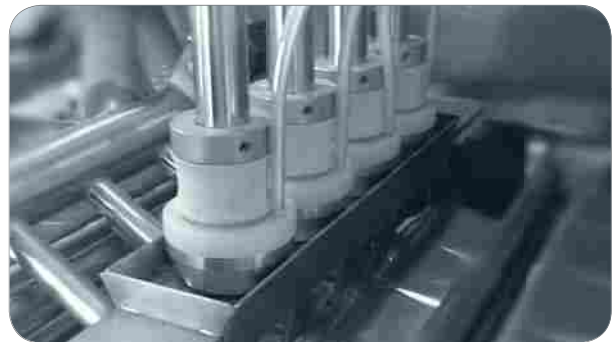

In order to improve product shelf life Universal Pack offers inline modified atmosphere packaging systems, commonly for food packaging, drugs, etc... The modification process is aimed at lowering the residual oxygen in stick-packs below 1%, in order to slow down the growth of aerobic organisms and the oxidation process.

INK JET PRINTING & VISUAL CONTROL

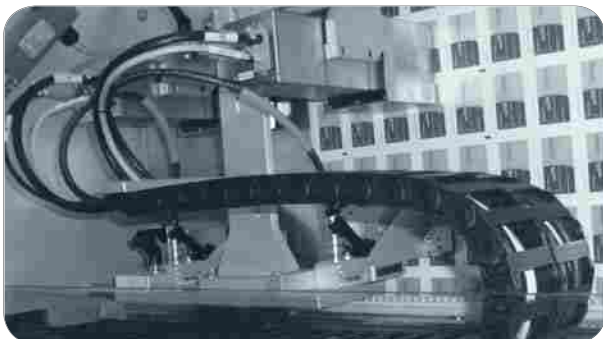

Advanced technologies for printing systems, for inline printing of text, images, etc. on each stick-pack. The camera checks for continuous printing in order to minimize errors during machine running.

OPENING GROUPS



The main groups on Universal Pack's machines can be easily opened and accessed; this simplifies and speeds-up the cleaning process. In addition, with only a few steps and no tools, groups can be disassembled and reassembled.

Meticulous attention to detail and quality

WINDOWS PC PANEL



Innovative interactive WINDOWS PANEL PC internally designed with a TPM philosophy. Training tutorials, maintenance and spare parts manuals can be integrated in the HMI. Integrated remote assistance software allows the machine to be remotely connected to Universal Pack or a supervisor PC.

HEATED PISTONS



Heated dosing system for products which must remain at a constant temperature. All parts in contact with the product can be heated by electrical heating elements, air or water, controllable by the machine's HMI.

CHILLED FORMING PIPES



Dosing system for products that have a low melting point. Thermal insulation can be provided by air or water. Universal Pack can offer turnkey solutions by including air or water cooling units.

REEL SPLICING



Besides the possibility to place on the machines both reels without shafts and double reels, Universal Pack has developed a new system for quick reel splicing in an easily accessible position. Thanks to these improvements reel change is faster, more user-friendly and film wastage is reduced.

DISASSEMBLY WITH NO TOOLS



Disassembly and reassembly require a great deal of patience, care and, above all time. Most of the parts in direct contact with the product are quickly and smoothly removable without tools, conforming to cGMP criteria (easy format change and ease of cleaning and maintenance).

SEALING PRESSURE CHECK



Universal Pack's machines can be equipped with a pressure sealing sensor to check in continuous the sealing pressure applied on film during stick formation. This system checks that each stick it's fully sealed to minimize imperfection on produced stick-packs.

Synthesis ALFA Complete Automatic Lines

USING PRE-GLUED FOLDED CARTONS

Complete automatic stick-pack lines entirely designed and constructed by Universal Pack composed of ALFA stick-pack machines, counting & stacking groups and horizontal cartoning

machines equipped with suitable dosing systems for the packaging of powders, granules, liquids, tablets in stick-packs and subsequent automatic introduction into pre-glued cartons.



LAYOUT

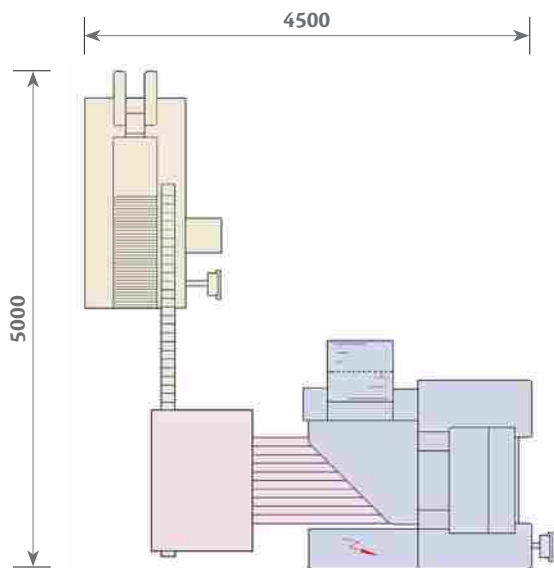

OPERATION DIAGRAM

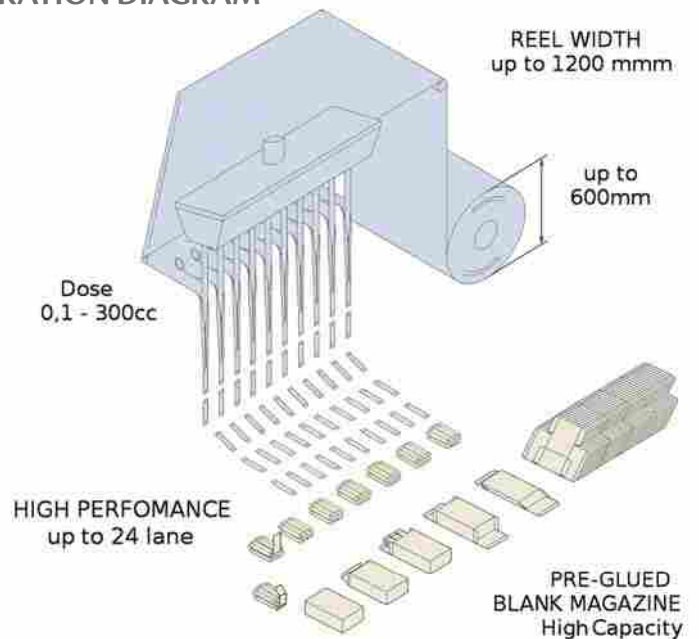

KEY TO COLOURS

- ALFA STICK-PACK MACHINE
- COUNTING & STACKING GROUP
- CARTON FORMING MACHINE

High efficiency, flexibility plus user-friendly design

USING FLAT BLANK CARTONS

Complete automatic stick lines entirely designed and constructed by Universal Pack composed of **ALFA** stick-pack machines,

counting & stacking groups carton forming and carton closing machines.



LAYOUT

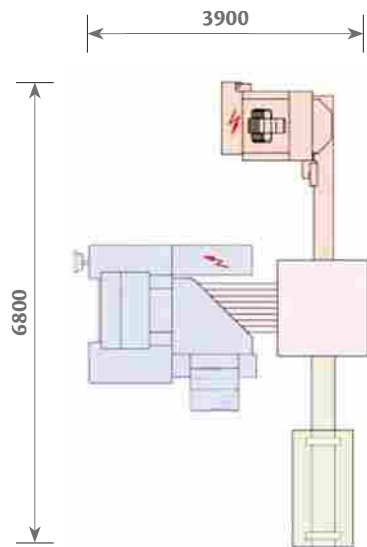

OPERATION DIAGRAM

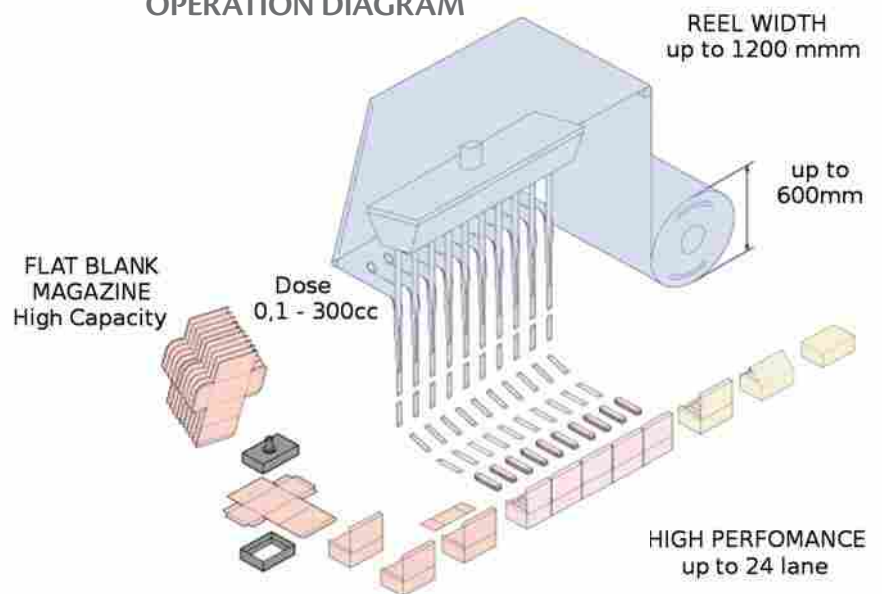

KEY TO COLOURS

■ CARTON ERECTING MACHINE
 ■ ALFA STICK-PACK MACHINE
 ■ COUNTING & STACKING GROUP
 ■ CARTON CLOSING MACHINE

Quality is not an optional, it is our daily pursuit

Synthesis **ALFA** Customized Applications

SYNTHESIS ALFA WITH CHECK WEIGHER AND LABELLING MACHINE



ALFA Stick-pack line configuration starting from pre-glued cartons for filling stick-packs in boxes. The machines can be equipped with a special check weigher and a labelling machine for boxes.

SYNTHESIS ALFA COMPLETE LINE WITH “BOMB-BAY” DISCHARGE



ALFA Stick-pack line, with “Bomb Bay” solution, combines the high productivity of Universal Pack’s **ALFA** machines with carton erecting machines, check weighers and carton closing machines.

Packaging solutions for every need

SYNTHESIS ALFA WITH POUCH MACHINE

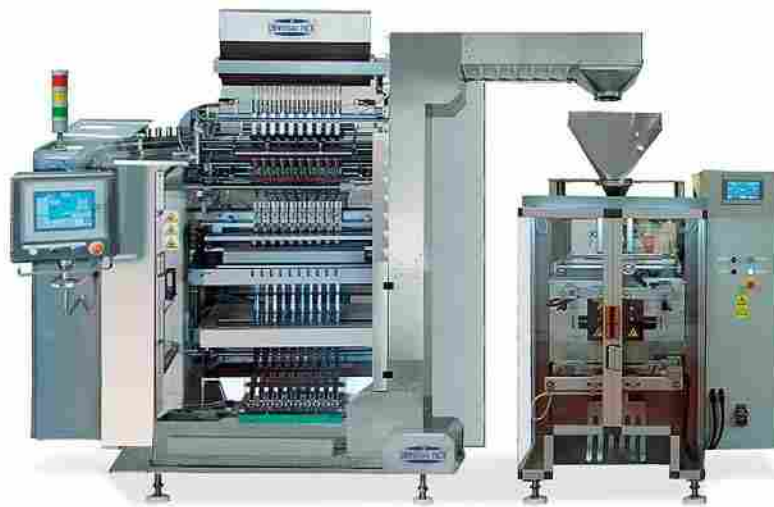

ALFA Stick-pack line configuration with pouch machinery.

Universal Pack machines can be connected to the most established worldwide pouch machinery, thereby satisfying every customer needs.

SYNTHESIS ALFA WITH CONTINUOUS MOTION CARTONING MACHINE



ALFA Stick-pack machines can be connected to intermittent or continuous motion cartoning machines, to satisfy all kind of customer's requirements.

High quality solution for monodose packaging

Universal Pack company profile



Founded in 1965, the factory has specialized in designing and constructing top-quality vertical multilane packaging machines and complete lines with respective cartoning systems.

The company is recognized world-wide as a packaging leader operating in the food, chemical, pharmaceutical, and cosmetic industries.

Universal pack also prides itself on customizing machinery specifically to the customer's demands. All these machines and complete lines are designed, manufactured and assembled in-house in the factory in Italy, which means Universal Pack is responsible to ensure the complete line is fully functional.

The 500 mq warehouse currently houses over 60.000 individually coded spare parts.

Universal Pack has quick and efficient access to an extensive and comprehensive computerized inventory of every single spare part, which allows for quick delivery times to customers.

Universal Pack achieved ISO 9001:2008 certification by TÜV in 2001; as a result, all relevant information is stored and easily accessible

when required. Universal Pack has the most sophisticated state-of-the-art tooling machinery, with which over 80% of our machines parts are produced. In this way not only the quality is controlled, but also the availability of the parts required either for new machine construction or spare parts.



**QUALITY MANAGEMENT
CERTIFICATION**
UNI EN ISO 9001:2008
n° 50 100 1592



**INDUSTRIAL SAFETY
CERTIFICATION**
n° 50 100 12341/BS
OHSAS 18001:2007

With complete control and understanding over the entire manufacturing process, Universal Pack manufactures extremely high-precision parts, quickly, effectively, with machine design innovation.



Project Design Department



Parts Workshop



CNC tooling machinery

Universal Pack at the forefront for over 50 years



Universal Pack is located in San Giovanni in Marignano, on the Adriatic coast, 30 minutes from Rimini and 1 hour from Bologna, the packaging capital of Italy also known as "Packaging Valley". The nearest airports are Bologna and Ancona, while the biggest and easiest to get to are in Milan and Rome.



AIRPORT	distance
RIMINI	20 km
ANCONA	80 km
BOLOGNA	120 km
MILAN	350 km
ROME	350 km

PEOPLE & PLANET

We want to have a positive impact on people and the planet. As a responsible company, operating more sustainably has always been at the core of our philosophy. We are strongly committed to investing in renewable energy and "energy efficient" technologies to help tackle climate change. Most of our energy needs are supplied by renewable sources such as solar panels, which allows us to reduce the impact of our CO2 emissions. This "zero energy" approach puts us on the forefront of the fight against climate change.



Assembly Department



Warehouse

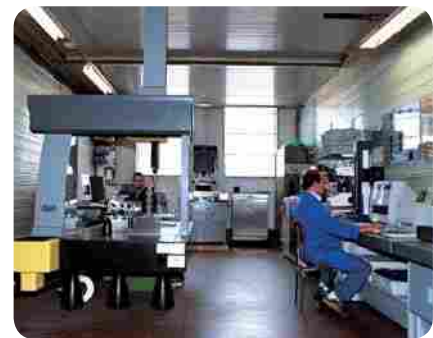

Quality Control Room

Universal Pack R&D team is investing in biosustainable packaging

Universal Pack's mission

Universal Pack presents itself as a designer and constructor of highly efficient, flexible and user-friendly stick machinery and complete lines, totally client-oriented.

WE PRIDE OURSELVES ON:

EXPERIENCE

Thanks to almost 50 years of experience, we have accumulated extensive knowledge about the packaging industry and its rigorous demands, we have worked with thousands different products and laminates in all markets: food, pharmaceutical, chemicals, cosmetics.

BESPOKE SOLUTIONS

Though the basic structure of our machine is the same, almost each one we construct is unique in some way, specifically tailored to the customer's stick size, number of lanes, dosing system, down-line, end-of-line packaging and a wide variety of options.

HIGH-TECH & HIGH-QUALITY SOLUTIONS

Our strength lies in constructing high-speed, high-precision and high-output solutions for particularly demanding customers. We can reach production of 2400 stick-packs per minute on a multi-lane machines. Furthermore, we can achieve very small doses up to 0,1g.

ROBUST & COMPACT MACHINERY

Once our machines are properly set up, they are capable of operating at the same speed for many years. Furthermore, they all feature a compact footprint and ergonomic design.

CUSTOMER SERVICE

Our main strength is our exceptional pre-sales consultation and after-sales follow up. Ongoing support, friendly assistance and courteous timely service are one of the main reasons most customer keep choosing us. Customer satisfaction is our mission and business priority.

TRAINING

In order to improve productivity, increase reliability, maximize the operational efficiency and reduce time loss, we support our customers with appropriate instruction and training programs, so that can quickly learn what and how to do.

TPM

We provide customers a wide range of tools aimed at improving machine capability through a better utilization of maintenance by following the philosophy of TPM " Total productivity maintenance".

EXCELLENCE

Our success is achieved through meticulous attention to detail and quality.



Entirely made in Italy with state-of-the-art technology



Sachet & stick-pack solutions
supplied worldwide
for all market sectors



A pioneer and consolidated leader in the world of packaging



UNIVERSAL PACK S.r.l.

Via Vivare 425, 47842

San Giovanni in Marignano (Rimini) - Italy

Tel. +39 0541 955 276 - Fax +39 0541 955 400

www.universalpack.it - info@universalpack.it

www.universalpack.it

